

1 ⚡ AC 220-240V □

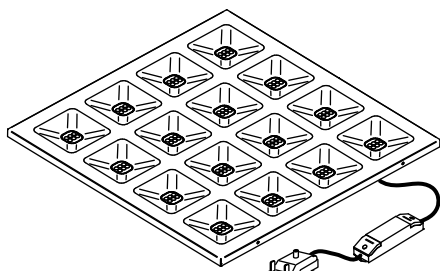

min. 2 x 0.75 mm²
max. 2 x 1.50 mm²

⚡ AC 220-240V + DALI ∞

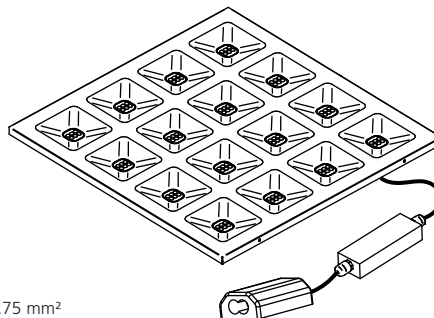

min. 5 x 0.75 mm²
max. 5 x 1.50 mm²

⚡ AC 220-240V + SSC

ta 35°C

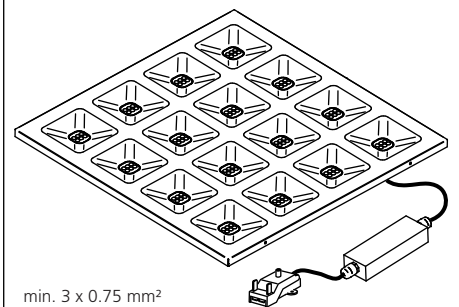

min. 3 x 0.75 mm²
max. 3 x 1.50 mm²

2

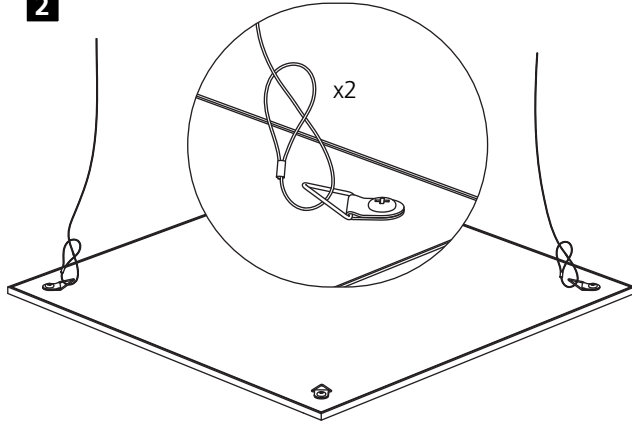

3 ⚡ AC 220-240V □

SSC

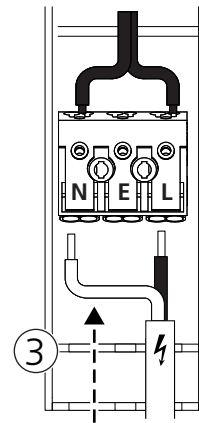
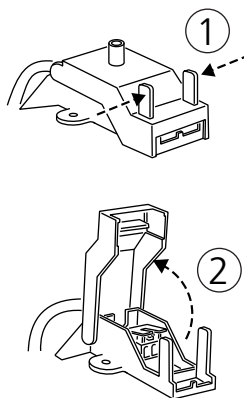

Total Max. 3 A

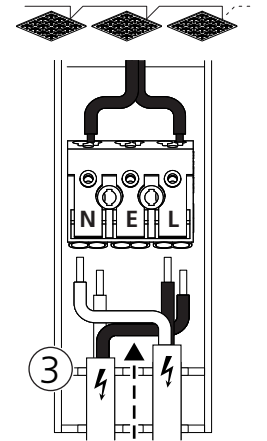

4 ⚡ AC 220-240V + DALI ∞

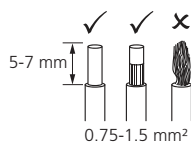
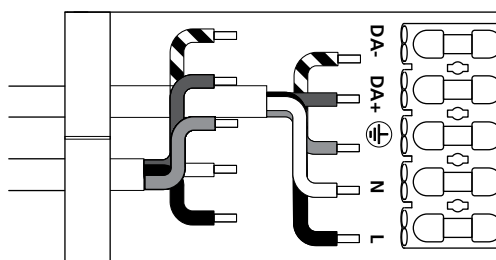
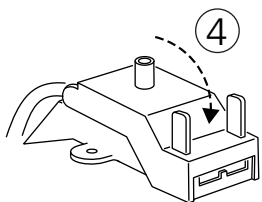

5

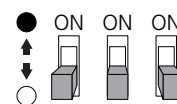

1	2	3	P [W]	0047250 0047256	0047251 0047257
●	●	●	34	4650	4500
●	●	○	32	4500	4300
●	○	●	30	4250	4000
●	○	○	27	3950	3700
○	●	●	24	3500	3300
○	●	○	21	3150	2950
○	○	●	18	2650	2450
○	○	○	15	2250	2050

6

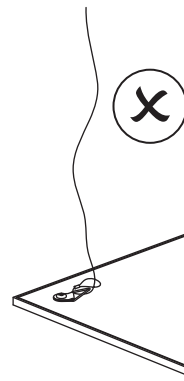
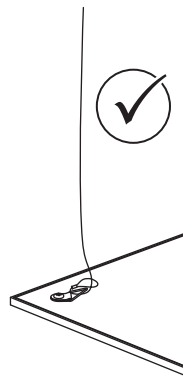
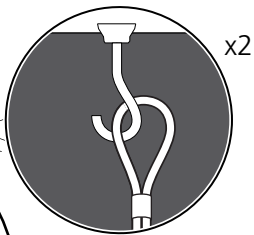
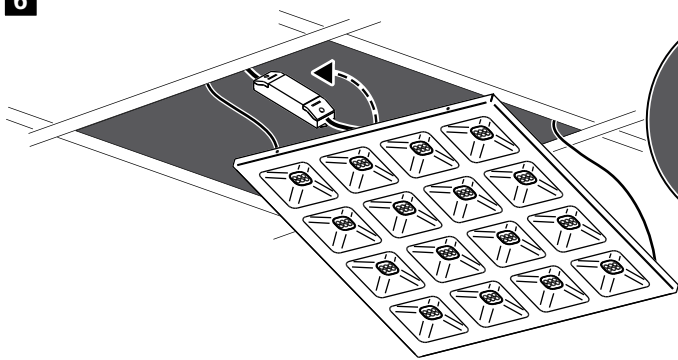

7

